



Coupling with the new SMS-55 Alarm and Monitoring Systems (AMS)

Ease of usability is UP!

The new JRCS SMS-55 AMS now has the function of connecting with J-S/Eco so while you are in the Control Room you can change settings for optimum efficiency and monitor high levels of energy saving.

SMS-55

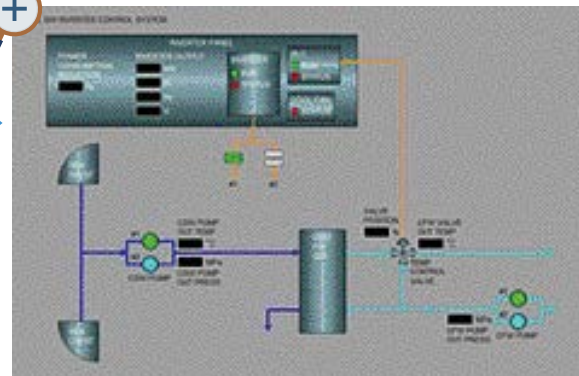
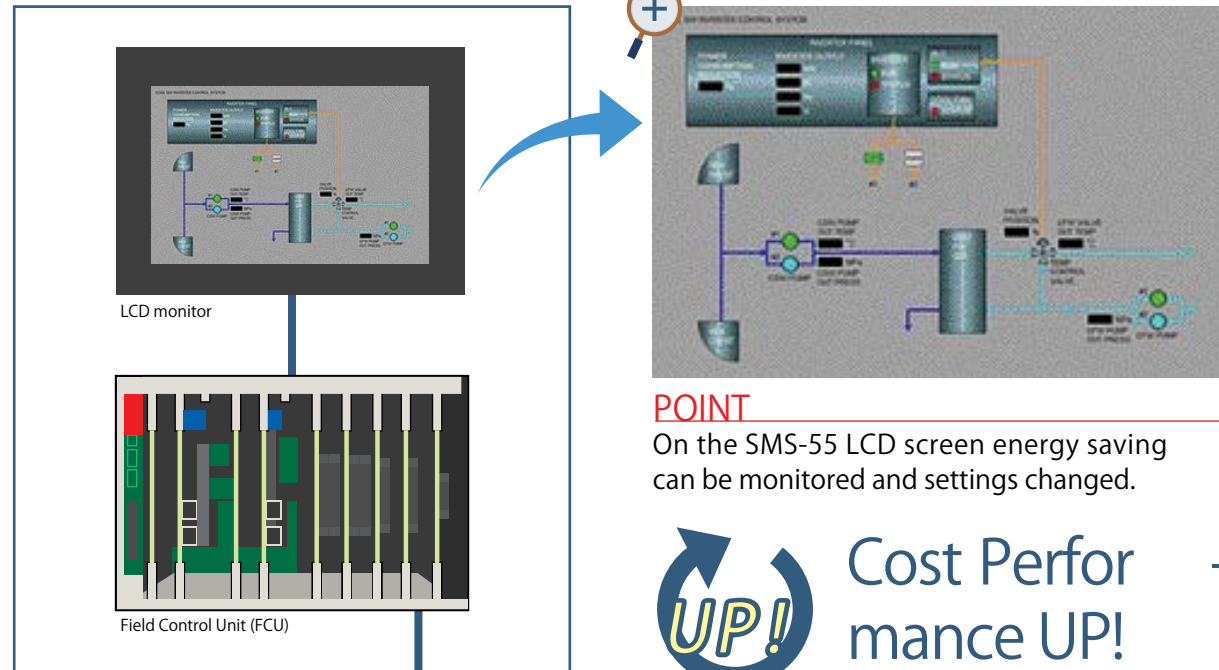

POINT

On the SMS-55 LCD screen energy saving can be monitored and settings changed.



Cost Performance UP!

JRCS is able to guarantee long and trouble free service with strong support by using our own components and not having to rely on commercially available PLCs.

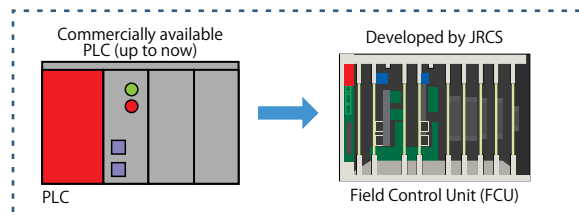

J-S/Eco

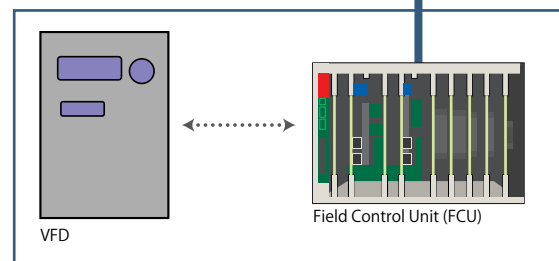

Reliability UP!

The SMS-55 controller Field Control Unit (FCU) has been developed in-house to withstand the rigors of the marine industry with improved serviceability.

JRCS JRCS Co. Ltd.

■ JRCS Shimonoseki (headquarters):
1-2-14 Higashiyamato-machi, Shimonoseki,
Yamaguchi, 750-8515 Japan
Tel: +81 83 261 0200 Fax: +81 83 261 0360
E-mail: jracs@jracs.co.jp
URL: www.jracs.co.jp

■ JRCS Tokyo (headquarters):
CIRCLES Shimbashi 11F, 2-11-13 Nishishimbashi,
Minato-ku, Tokyo, 105-0003 Japan
Tel: +81 3 5948 5952 Fax: +81 3 5948 5953

■ JRCS Toyoura:
2155 Kawatana, Toyoura-cho, Shimonoseki,
Yamaguchi, 759-6301 Japan
Tel: +81 83 775 1100 Fax: +81 83 775 1105

■ The Netherlands Subsidiary: JRCS Euro Marine Service B.V.
Prof. J.H. Bavincklaan 7, Unit 202, 1183 AT Amstelveen, The Netherlands
Tel: +31 20 2996583

■ Singapore Subsidiary: JRCS Engineering Singapore Pte. Ltd.
26 Boon Lay Way #01-82 TradeHub 21, 609970 Singapore
Tel: +65 6515 8286 Fax: +65 6515 9334

■ Shanghai Subsidiary: JRCS (Shanghai) Co., Ltd.
Rm #1223, Cimic Tower, #1090 Century Blvd Road, Pudong New Area,
Shanghai, 200120, China
Tel: +86 21 2022 0052 Fax: +86 21 2022 0053

JRCS Smart Eco System

J-S/Eco

J-S/Eco plus

J-S/Eco is a JRCS registered trademark.

Reduce running costs with a more efficient system! Guaranteed to return your investment, and more!

Energy-saving Variable Frequency Drive for Pumps and Fans

J-S/Eco plus

Eliminates costly waste by precisely controlling ventilation in the engine room

J-S/Eco

Enables precise control using the VFD and controller based on dynamic main engine load and seawater temperature

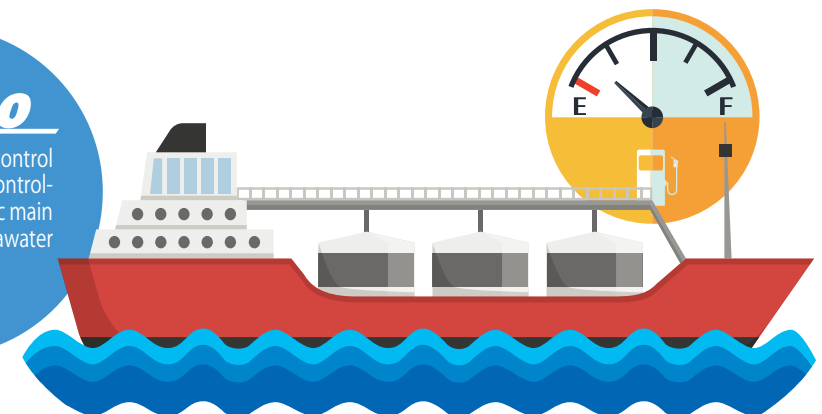

Benefits

Power

Approx.

87%

Power Saving

results proven by actual operation test.

- 1 A quick, safe and smart investment!
Substantial energy savings guarantee a quick return of investment
- 2 Produced by a marine industry veteran!
JRCS is a proven expert in safe and efficient electrical design
- 3 Good for the environment!
Pumps and fans which use less energy generate less pollution

JRCS JRCS Smart Series

Energy-saving Variable Frequency Drive for Pumps

Present cooling seawater pumps in your vessel...

- 1 are running 100% of the time regardless of actual necessity
- 2 are wasting precious fuel by using more power than needed
- 3 are costing you extra money which can be saved safely and efficiently

Power

Approx. **87%** energy savings

Amazing results, proven by an actual operation test onboard a large container vessel.

○Max.seawater temp:26.2°C ○Input power to motor with J-S/Eco:12 kW; without J-S/Eco:98kW

○Annual fuel consumption per kW:1.95t/kW 98kW-12kW=86kW 86kW x 1.95t/kW=**167t/yr**

※The above figures show the trial results; however the actual energy-saving rate may vary according to each vessel.

System Diagram

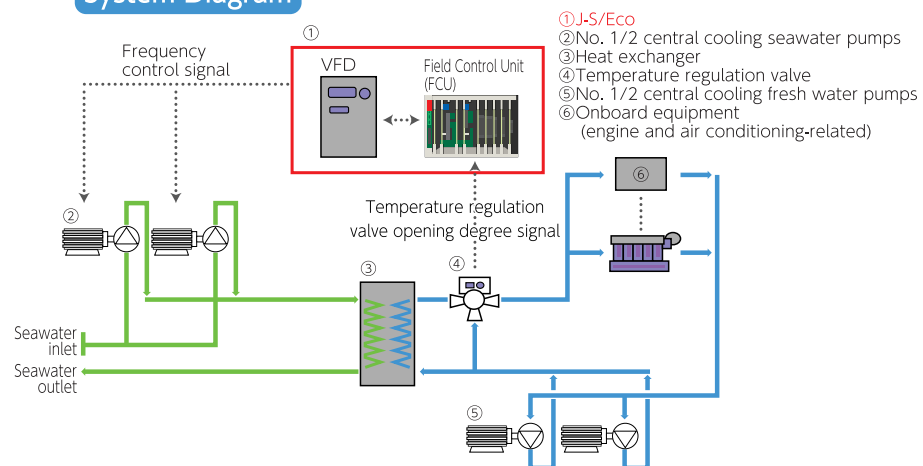

Utilizing the Variable Frequency Drive enables fine control over motors and seawater temp. Giving you optimum flow of cooling seawater.

Trial Data



A test voyage has proven that J-S/Eco can keep the motor control frequency below 50%, leading to energy savings and reduced power usage. This means that you can get your initial investment back in no time!

Energy-saving Variable Frequency Drive for Fans

Present ventilation fans in your vessel are wasting energy!

Engine Room ventilation fan capacity is defined by ISO8861. Capacity is defined as the amount of air necessary for fuel combustion plus the amount of air necessary for heat exhaust when the main and auxiliary equipment is running at 100%.However,since the equipment does not run at full power 24/7, the fans are working harder than necessary.

Power

Approx. **65%** energy savings

Proven results of an actual onboard test on a 20,000 ton tanker.

○Input power to motor with J-S/Eco plus:10kW; without J-S/Eco plus:27.5kW

○Annual fuel consumption per kW;1.95t/kW 27.5kW-10kW=17.5kW 17.5kW x 1.95t/kW=**34.2t/yr**

※The above figures show the trial results; however the actual energy-saving rate may vary according to each vessel.

System Diagram

J-S/Eco plus gives you full control over the volume of engine room ventilation. Maintaining an atmospheric pressure of 50Pa is a great save in energy. While at dock a vast reduction in noise has also been demonstrated.

Trial Data

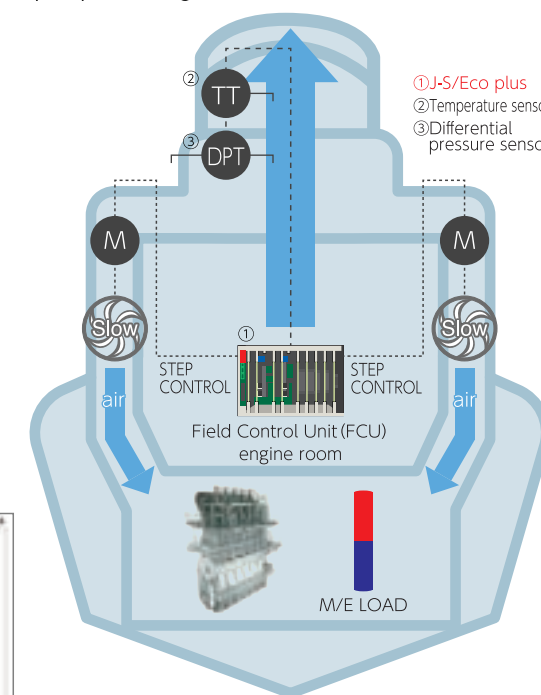

As this data confirms, J-S/Eco plus results in the optimum volume of ventilation from engine output.